



K4 SERIES

NEW!

ENGINE

Brand, Model	Perkins, 904J-E36TA
Number of cylinders	4
Max. Power	100 HP (74,4 Kw) @2200 rpm
Max. Torque	430 Nm @1500 rpm
Displacement	3,621 cc
Bore & Stroke	ø 98 x 120 mm
Emission Class	EU:Stage 5, US: Tier 4 final
High power and torque output, water cooled turbocharged diesel engine.	

AXLES

- Heavy duty service type axles
- Planetary outboard type reduction
- Total 16 degrees oscillation on the front axle
- Torque proportional type front axle differential
- LSD (Limited Slip Differential) type rear axle differential
- Locking type rear axle differential (optional)

CAB&HOOD

- Widened visual angle
- Ergonomic & Aesthetic Interior Design
- High capacity A/C system (option)
- Improved ventilating with 17 air nozzles
- Cool-box (with A/C system)
- ROPS and FOPS certificated cab
- 4.3" TFT display on front and on rear side panel
- Pool type floor mats
- Mechanical lever control
- Seat Mounted Controls improve Operator Comfort & Ergonomics (with joysticks model)
- Seat entegreted radio control button (with joysticks model)
- TIPSHIFT (FNR) function
- RTD (Return to dig)
- Multi purpose bucket with proposal control
- Autotilt steering wheel
- Loader boom lock
- Double brake systsem
- Storage boxes
- Foldable side steps
- Phone and cup holder
- Interior led lights
- MP3 radio
- Bluetooth radio (option)
- USB charging ports
- Openable cooling package
- Smartlink (option)

HYDRAULIC SYSTEM

Simple, reliable and high efficient tandem gear pump

Main pump flow	90 l/min @2200 rpm
Pressure	255 bar
Auxiliary pump flow	57 l/min @2200 rpm
Pressure	170 bar
Closed type hydraulic system with variable displacement piston type pump, renewable flowsharing and valves with regeneration (Optional)	
Main pump flow	163 l/min
Pressure	255 bar

DRIVING SPEED

1 st gear	4	km/h
2 nd gear	7	km/h
3 rd gear	9	km/h
4 th gear	15	km/h
5 th gear	22	km/h
6 th gear	40	km/h

TRANSMISSION

- Autoshift transmission for heavy duty service
- Torque converter with 2,38:1 stall ratio
- Electrically controlled 2 Wheel drive or 4 Wheel Drive selection
- 6 forward, 3 reverse gears (Lock-Up is option)
- Transmission oil cooler
- A neutral circuit allows starting only when the control lever is in neutral position for safety.

TIRES

Front	16/70 - 20 12 Ply Rating
Rear	16,9 - 28 14 Ply Rating (Optional : 18,4- 26 12 Ply Rating)

FILLING CAPACITIES

Engine oil pump	10	L
Engine cooling system	16	L
Fuel Tank	140	L
Hydarulic oil tank	70	L
Transmission oil	16	L
Ad Blue	15	L

OPERATING WEIGHT

Operating weight with standard equipment : 9240 kg

Operational weight, complying with the ISO 6016 standards, includes full fuel tank, hydraulic system and other liquids, 75 kg operator weight and standard equipped machine weight. Optional equipments are not included.

HMK102BK4

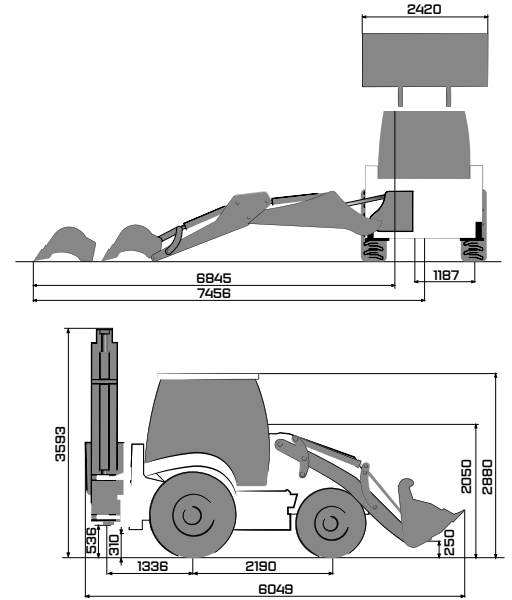
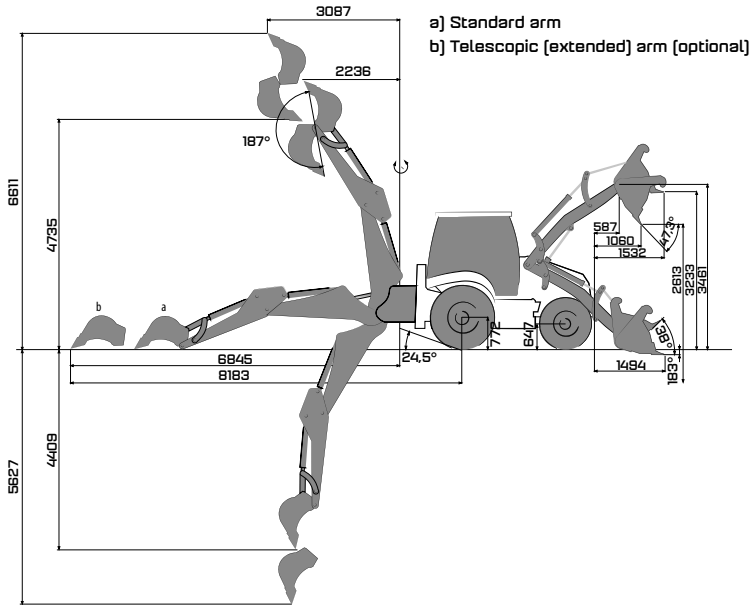



LOADER PERFORMANCE

6 in 1 bucket capacity	1.1 m ³
Max. bucket breakout force	6762 kgf
Max. loading arm breakout force	7429 kgf
Lifting capacity to max. height	3687 kg







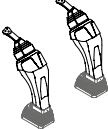
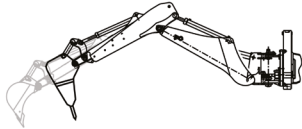
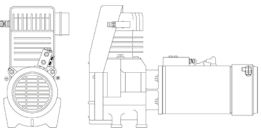
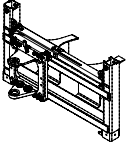





BACKHOE PERFORMANCE

	Standard arm	Telescopic arm extended	Telescopic arm retracted
Bucket capacity		0.18 m ³	
Max. bucket breakout force	6865 kgf	7023 kgf	7021 kgf
Max. arm breakout force	3290 kgf	2231 kgf	3160 kgf

OPTIONAL ACCESSORIES

			
Air conditioner	MSS (Motion Stabilizer System)	Seat mounted joystick	Hydraulic breaker inst. + Telescopic arm
			
Air Compressor	Powerslide		

OPTIONAL ATTACHMENTS

					
Snow blade	Timber grab	General purpose bucket	Trapezoidal ditch bucket	Ripper	Tilting bucket
					
Clamshell grab	Backhoe bucket of different sizes	Hydraulic breaker	Auger	Fork arms with quick coupler	Fork arms, for quick couple mechanism

HIDROMEK®

FACTORY - HEAD OFFICE
Ahi Evran OSB Mahallesi Osmanlı Caddesi No:1 06935 Sincan / ANKARA / TURKEY
Tel: (+90) 312 267 12 60 Fax: (+90) 312 267 12 39
www.hidromek.com

Notice:
Hidromek has the right to modify the specifications and design of the model indicated on this brochure without prior notice.