



K4 SERIES

NEW!

ENGINE

Brand, Model	Perkins, 904J-E36TA
Number of cylinders	4
Max. Power	100 HP (74,4 Kw) @2200 rpm
Max. Torque	430 Nm @1500 rpm
Displacement	3,621 cc
Bore & Stroke	ø 98 x 120 mm
Emission Class	EU:Stage 5, US: Tier 4 final

High power and torque output, water cooled turbocharged diesel engine.

TIRES

Front / Rear	16,9 - 28 14 Ply Rating
--------------	-------------------------

CAB&HOOD

- Widened visual angle
- Ergonomic & Aesthetic Interior Design
- High capacity A/C system (option)
- Improved ventilating with 17 air nozzles
- Cool-box
- ROPS and FOPS certificated cab
- 4.3" TFT display on front and 7" on rear side display
- Pool type floor mats
- Seat Mounted Controls improve Operator Comfort & Ergonomics
- Seat entegreted opera control button
- TIPSHIFT (FNR) function
- RTD (Return to dig)
- Multi purpose bucket with proposal control
- Autotilt steering wheel
- Loader boom lock
- Double brake systsem
- Storage boxes
- Foldable side steps
- Phone and cup holder
- Interior led lights
- MP3 radio
- Bluetooth radio (option)
- USB charging ports
- Openable cooling package
- Smartlink
- Air suspension seat
- Mechanical forklift attachment
- Auto engine stop
- Auto throttle
- LED working lighths
- LED step lighths
- ISO patternsifter

HYDRAULIC SYSTEM

Closed type hydraulic system with variable displacement piston type pump, renewable flowsharing and valves with regeneration

Main pump flow	163 L/min @2200 rpm
Pressure	255 bar

DRIVING SPEED

1 st gear	4	km/h
2 nd gear	7	km/h
3 rd gear	9	km/h
4 th gear	15	km/h
5 th gear	24	km/h
6 th gear	40	km/h

AXLES

- Heavy duty service type axles
- Planetary outboard type reduction
- Total 16 degrees oscillation on the front axle
- Torque proportional type front axle differential
- LSD (Limited Slip Differential) type rear axle differential (optional)
- Locking type rear axle differential (optional)

TRANSMISSION

- Autoshift transmission for heavy duty service
- Torque converter with 2,38:1 stall ratio
- Electrically controlled 2 Wheel drive or 4 Wheel Drive selection
- 6 forward, 3 reverse gears with Lock-Up
- Transmission oil cooler
- A neutral circuit allows starting only when the control lever is in neutral position for safety.

FILLING CAPACITIES

Engine oil pump	10	L
Engine cooling system	16	L
Fuel Tank	140	L
Hydarulic oil tank	70	L
Transmission oil	16	L
Ad Blue	15	L

OPERATING WEIGHT

Operating weight with standard equipment : 9640 kg
 Operational weight, complying with the ISO 6016 standards, includes full fuel tank, hydraulic system and other liquids, 75 kg operator weight and standard equipped machine weight. Optional equipments are not included.

HMK 102s K4

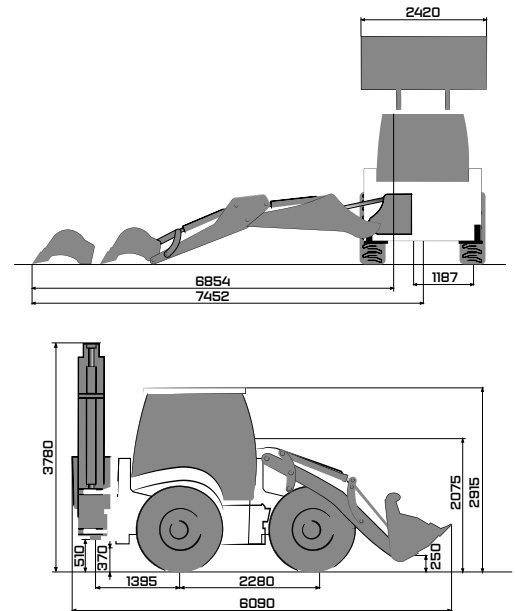
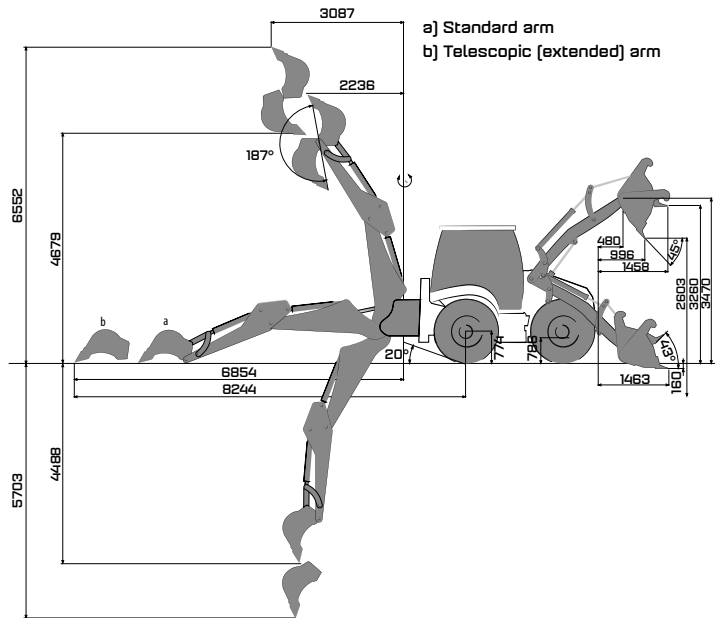

LOADER PERFORMANCE

6 in 1 bucket capacity	1.2 m ³
Max. bucket breakout force	6762 kgf
Max. loading arm breakout force	7429 kgf
Lifting capacity to max. height	3687 kg

BACKHOE PERFORMANCE

	Standard arm	Telescopic arm extended	Telescopic arm retracted
Bucket capacity		0.18 m ³	
Max. bucket breakout force	6865 kgf	7023 kgf	7021 kgf
Max. arm breakout force	3290 kgf	2231 kgf	3160 kgf

STANDART ACCESSORIES



Air conditioner



MSS (Motion Stabilizer System)

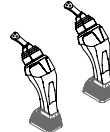

Seat mounted joystick

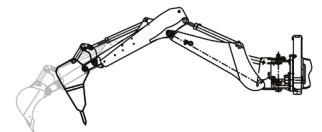

Hydraulic breaker inst. + Telescopic arm

OPTIONAL ACCESSORIES

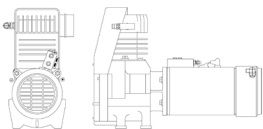

Air Compressor

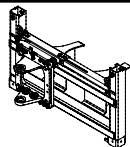

Powerslide

OPTIONAL ATTACHMENTS



Snow blade



Timber grab



General purpose bucket



Trapezoidal ditch bucket



Ripper



Tilting bucket



Clamshell grab

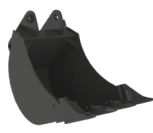

Backhoe bucket of different sizes



Hydraulic breaker



Auger



Fork arms with quick coupler



Fork arms, for quick couple mechanism

HIDROMEK®

FACTORY - HEAD OFFICE

Ahi Evran OSB Mahallesi Osmanlı Caddesi No:1 06935 Sincan / ANKARA / TURKEY
Tel: (+90) 312 267 12 60 Fax: (+90) 312 267 12 39
www.hidromek.com

Notice:
Hidromek has the right to modify the specifications and design of the model indicated on this brochure without prior notice.